

searchlight

www.searchlightelectric.com

4048-8

QL01990

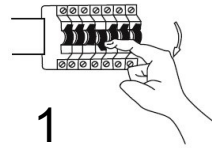

1

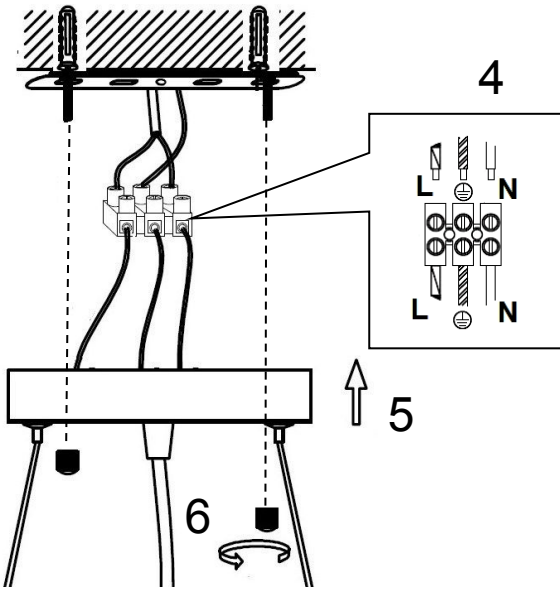

4

5

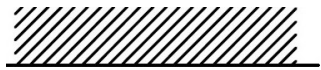

2



3

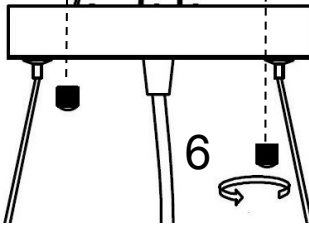
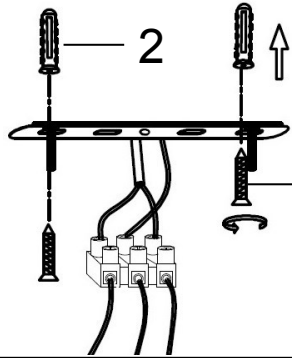

6

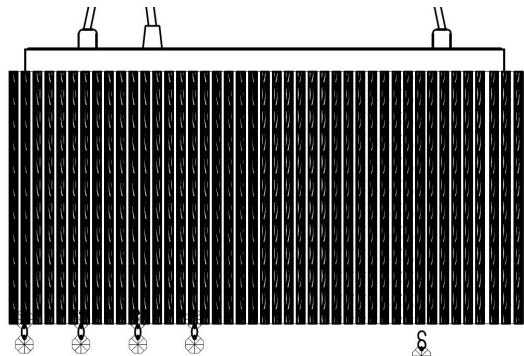

7



8

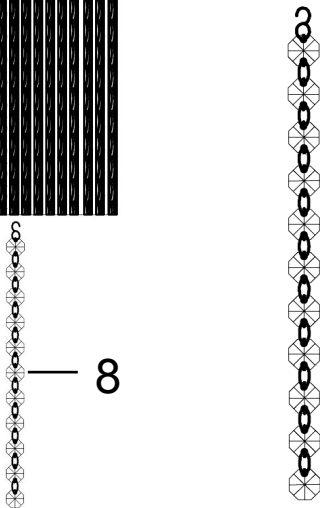

=91Pcs

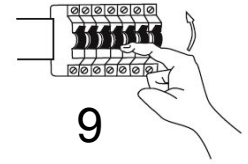

9

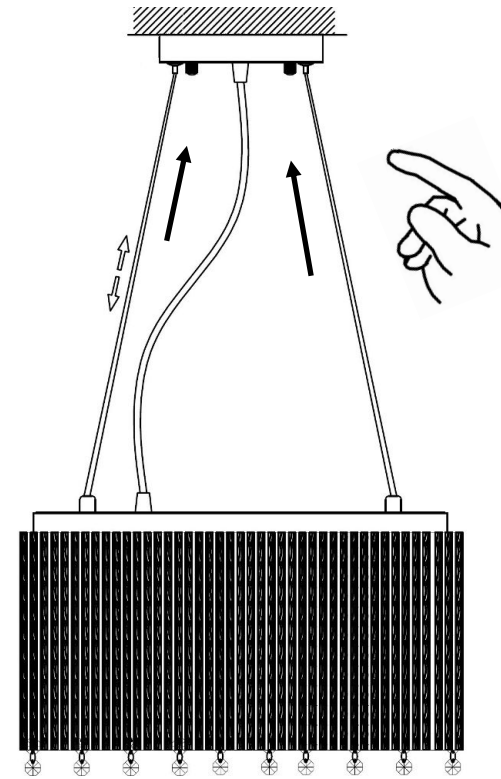

TO REDUCE THE HEIGHT - HOLD THE WIRES AND PUSH UP

TO INCREASE THE HEIGHT - PUSH THE PINS IN TO RELEASE THE WIRES

