

Installation and Safety Instructions

Outdoor Wall Light Fitting

Safety Warnings

These instructions are for your safety. Please read through them thoroughly before use and retain them for future reference. If you are in any doubt about installing this product, consult a qualified electrician.

This product is suitable for use outdoors but should not be immersed in water / sited in areas likely to be heavily splashed, either from above or below, or subjected to standing water.

This product is rated IP44(definition e.g. splash proof / rain proof etc). Ensure that the screws and cable entry points are sealed to maintain the IP rating of the product.

The battery must not be opened, destroyed or incinerated. In the unlikely event that the battery needs replacing - only use a battery of the same type and specification.

The solar panel has an integrated daylight sensor - enabling the light to come on at dusk and switch off at dawn. Ensure the product is located in a sunny position to ensure effective recharging of the battery.

Avoid locating the product in areas which are subject to interference from other light sources, (street lamps etc) as the product may not operate at night.

To test the light and check if it is switched on, cover the solar panel and the light should operate. Initial charging for 1-2 days may be necessary.

This product may contain delicate parts – be careful during handling and maintenance to avoid breakage.

The product must be securely fixed to the mounting surface using the screws and wall plugs supplied. The screws and wall plugs supplied are suitable for "masonry" only. Other fixings are not supplied and must be purchased.

Decide on the optimum location for the product. The recommended install height is 1-2 metre, in full sun position, in order to maximise solar panel charging.

Never put anything on the product or hang anything on any part of this product.

Waste electrical products should not be disposed of with household waste. Please recycle where facilities exist. Check with your Local Authority or local store for recycling advice..

Care and maintenance

Clean with a dry cloth only. Do not use liquid or abrasive cleaners on this product.

Troubleshooting

If you have any doubt about installation/use of this product, consult a qualified electrician.

Assembly Instructions

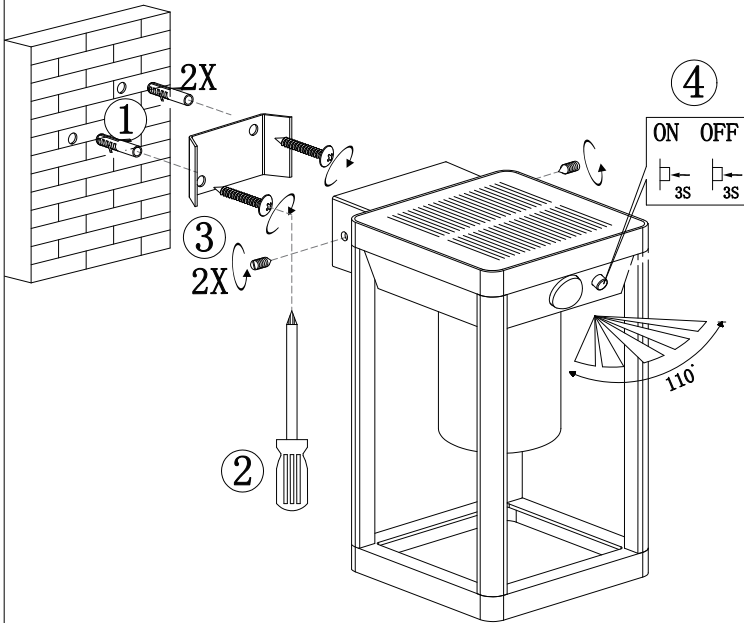

1 CLICK
20 LUMEN
3"

Press and hold the switch for 3 seconds to turn on, the product will stay on at 20Lm.

2 CLICK
70 LUMEN
20 LUMEN
1"

After mode 1, press the switch to change to mode 2. Product will stay on at 20Lm and increase to 70Lm when motion is detected (This will stay at 70Lm for 25 seconds then dim to 20Lm and stay lit).

3 CLICK
180 LUMEN
OFF
1"

After mode 2, press the switch to change to mode 3. Product will be 180Lm when motion is detected and will turn off after 25 seconds.

4 CLICK
OFF
3"

Press and hold the switch for 3 seconds to turn it off.

Detection Range - $8 \pm 2m$

Battery Replacement

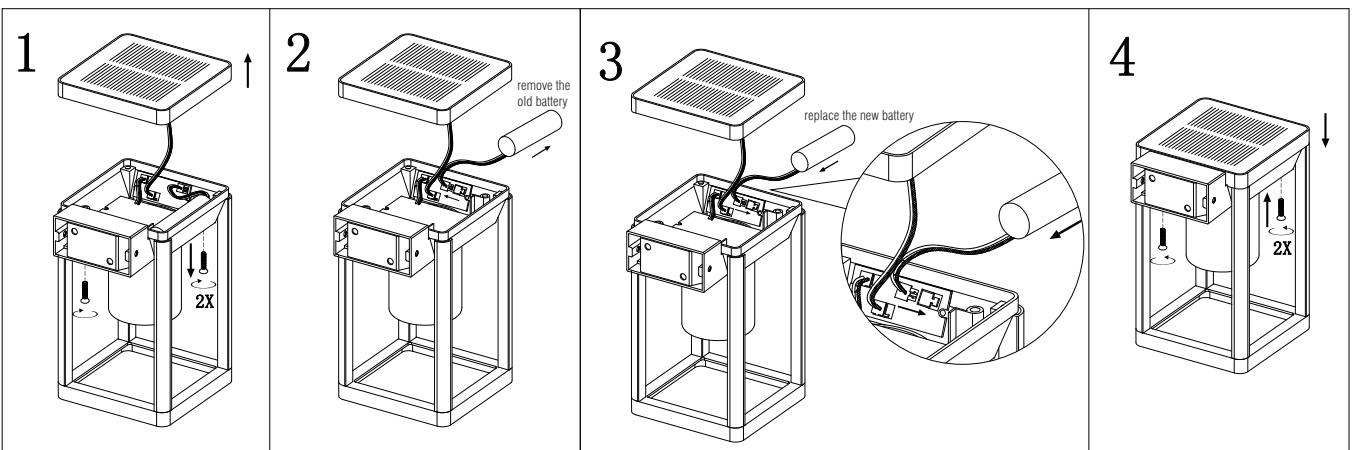

- (EN) Scan QR code for multi-language
- (FR) Scannez le code QR pour plusieurs langues
- (ES) Escanee el código QR para varios idiomas
- (PL) Zeskanuj kod QR dla wielu języków
- (DE) Scannen Sie den QR-Code nach mehreren Sprachen
- (IT) Scansiona il codice QR per multilingua



UK Manufacturer: BH17 7BY
EU Manufacturer: 1 Gnarrenburg, 27442